

202FA

202FA

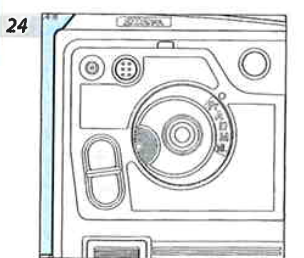

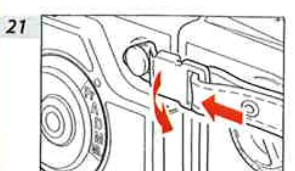
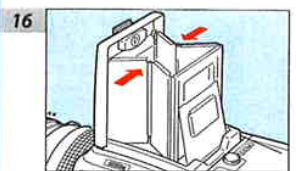
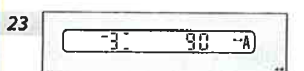
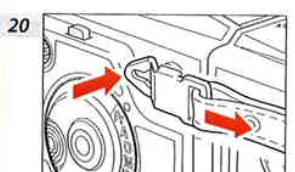
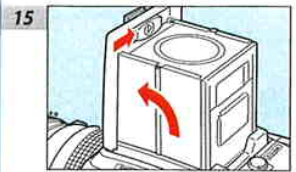
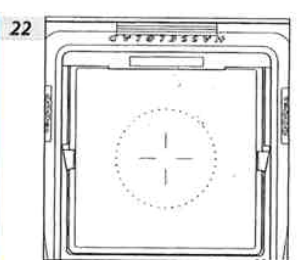
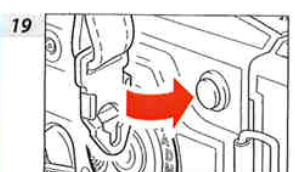
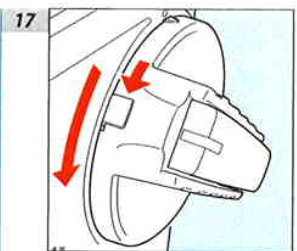
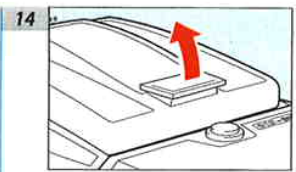
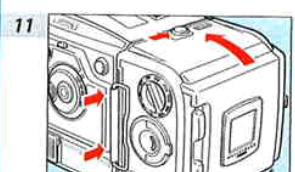
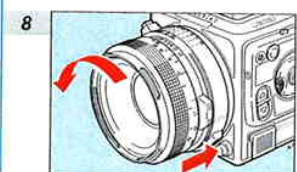
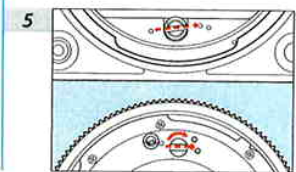
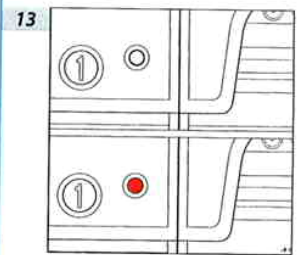
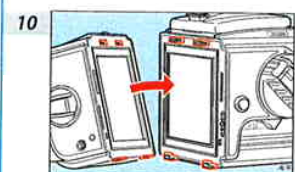
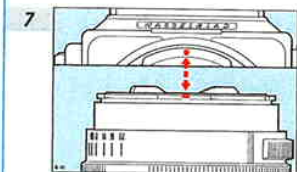
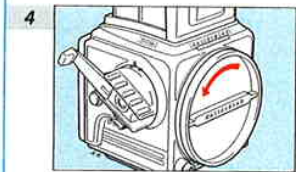
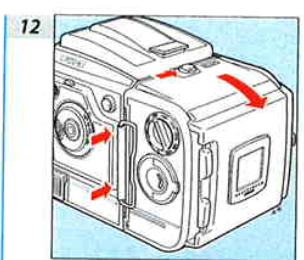
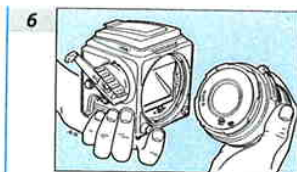
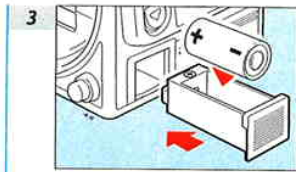
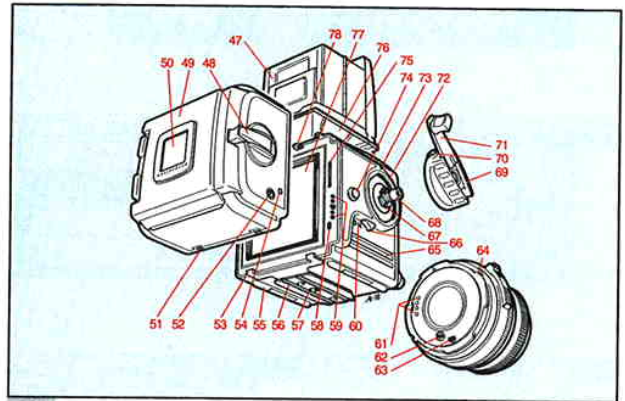
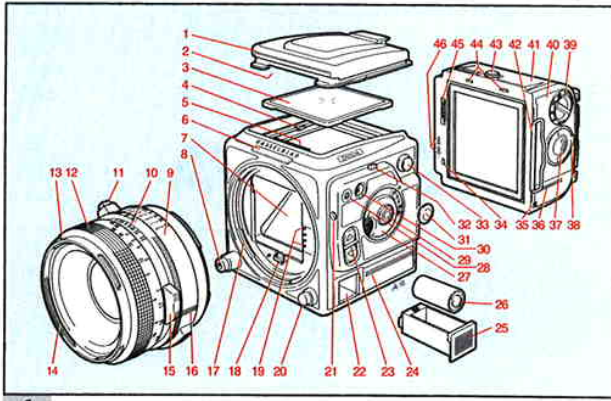
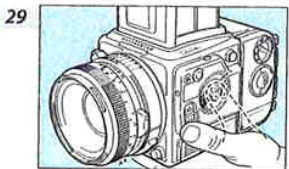
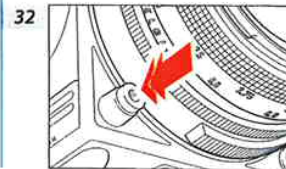
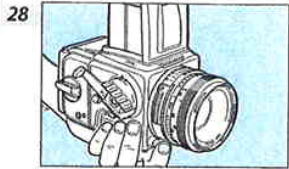
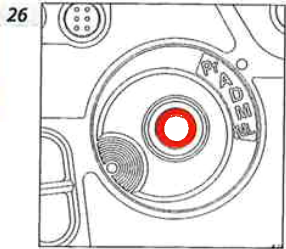
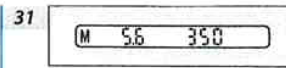
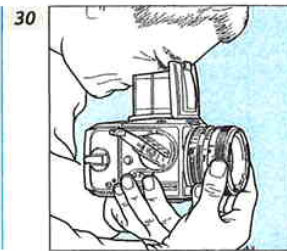
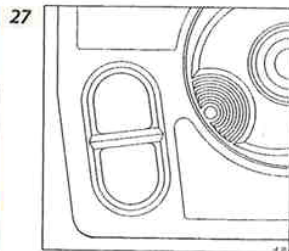
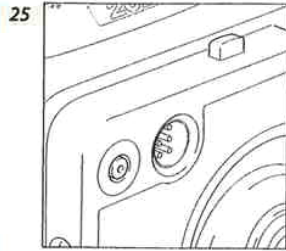

34a	↔	34f	8	34k	⏪
34b	M	34g	2'	34l	A
34c	⏻	34h	3'	34m	⚠
34d	DIFF	34i	ISO		
34e	±	34j	🔋		

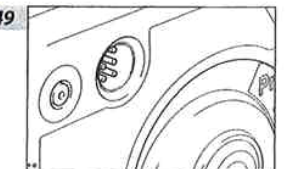
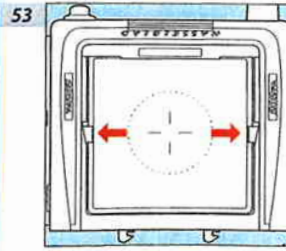
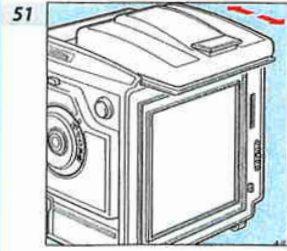
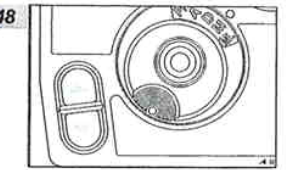
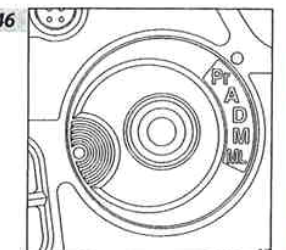
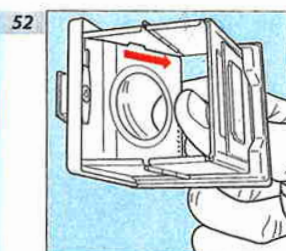
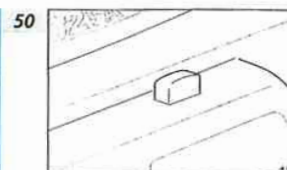
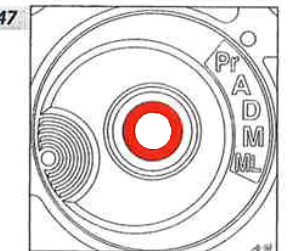
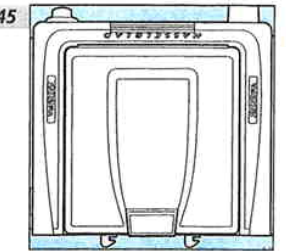
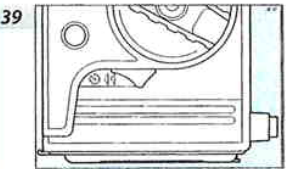
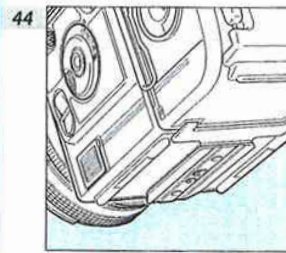
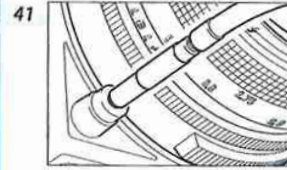
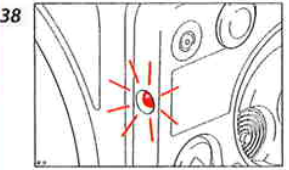
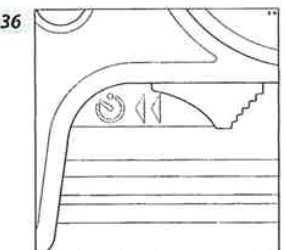
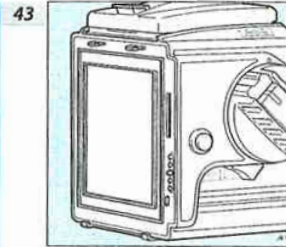
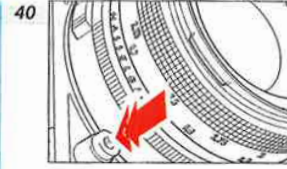
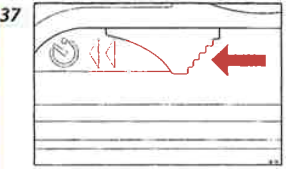
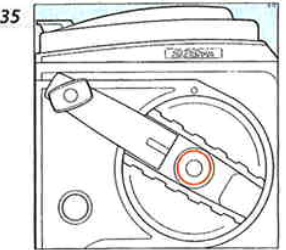

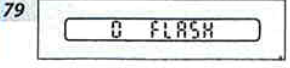
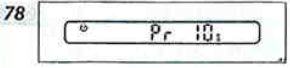
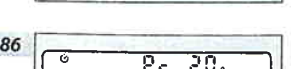
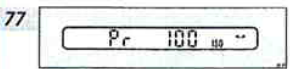
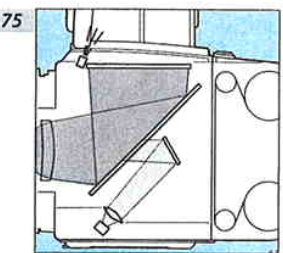
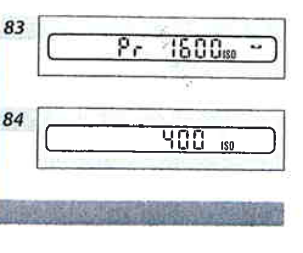
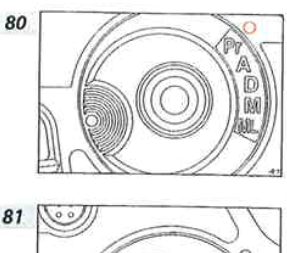
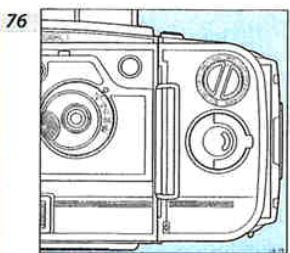
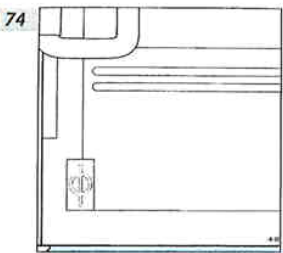
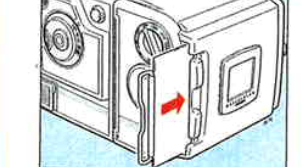
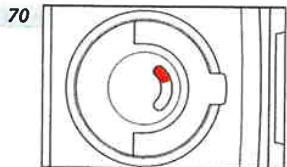
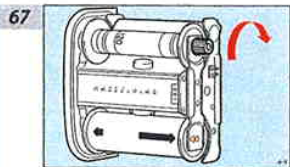
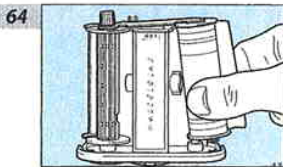
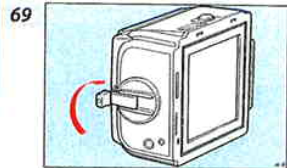
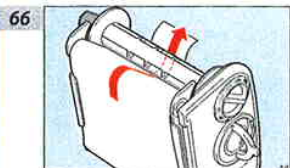
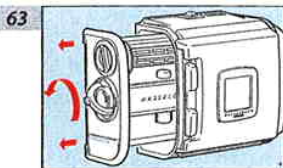
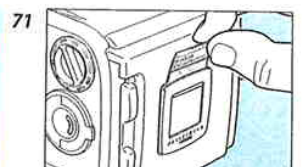
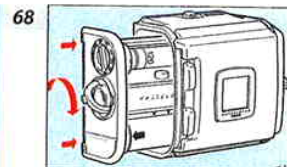
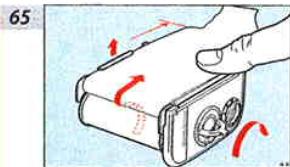
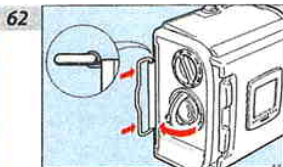
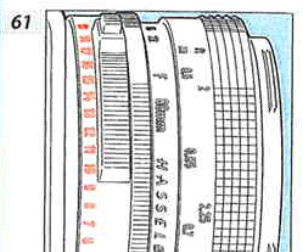
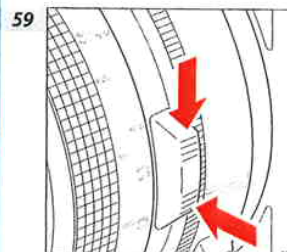
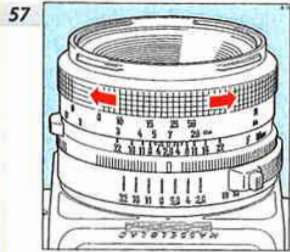
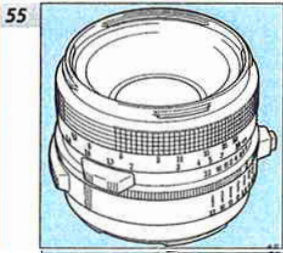
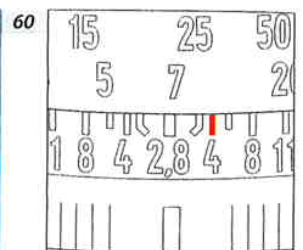
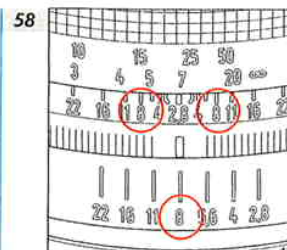
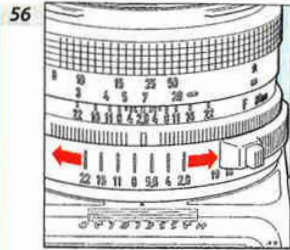
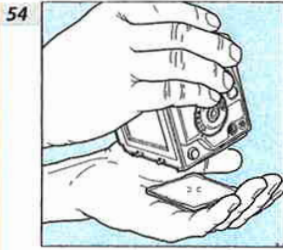

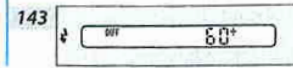
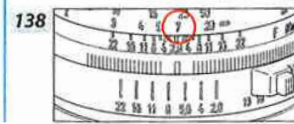
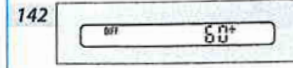
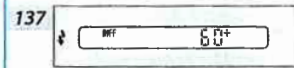
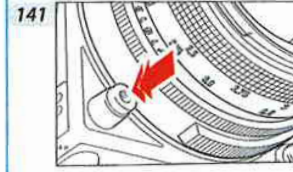
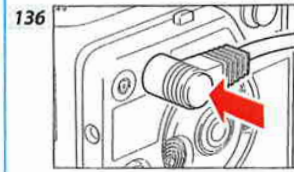
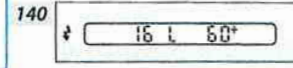
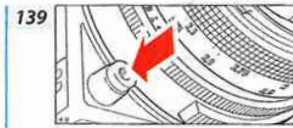
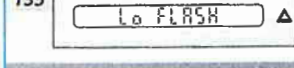
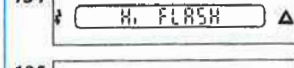
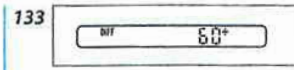
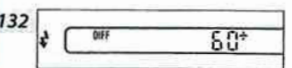
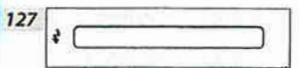
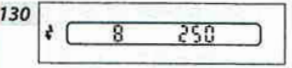
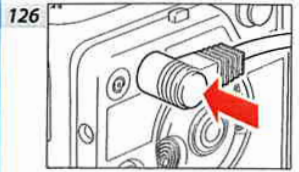
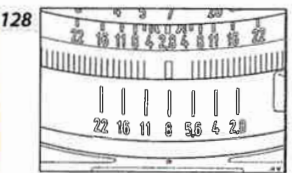
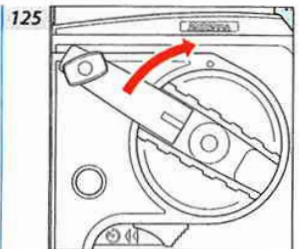
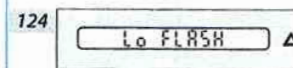
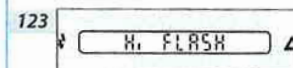
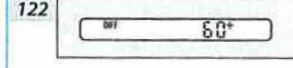
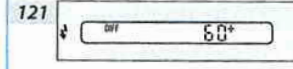
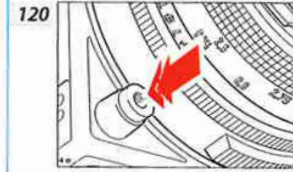
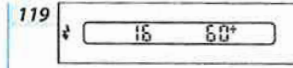
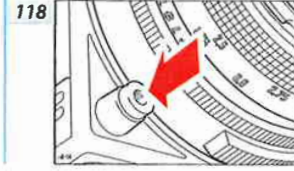
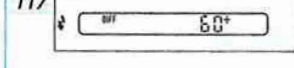
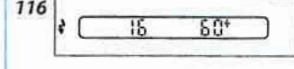
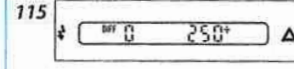
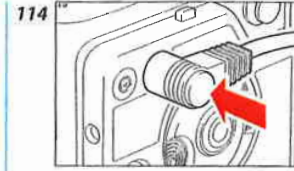
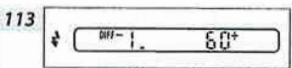
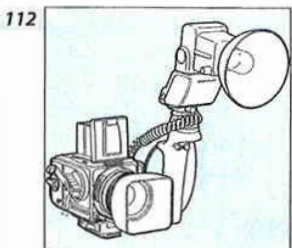
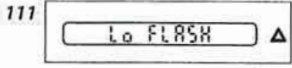
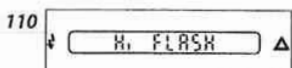
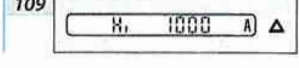
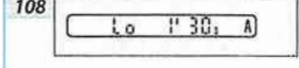
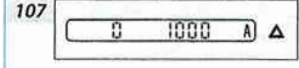
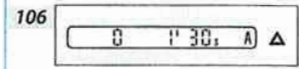
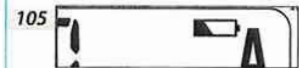
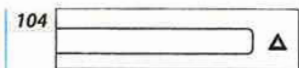
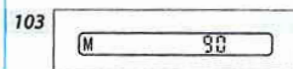
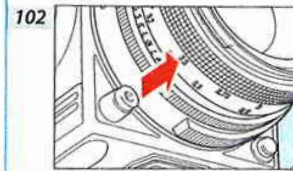
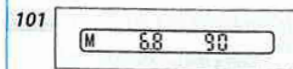
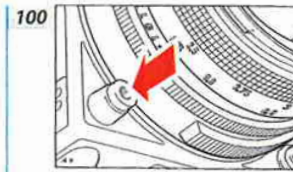
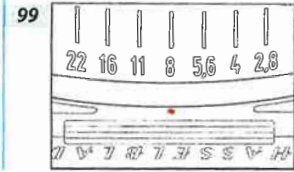
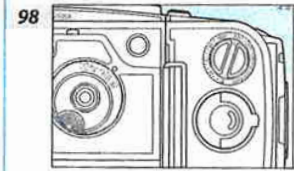
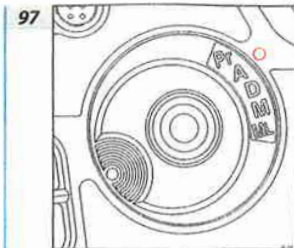
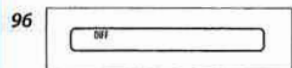
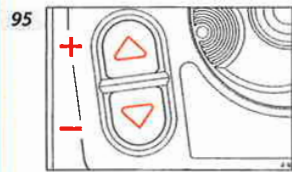
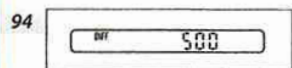
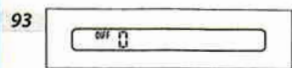
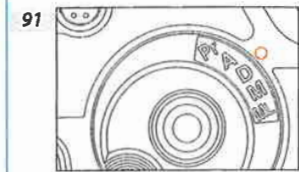
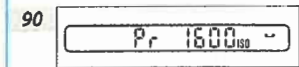
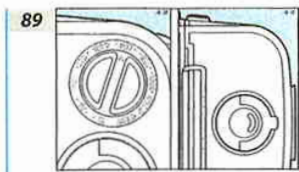

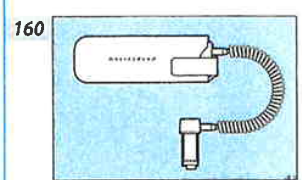
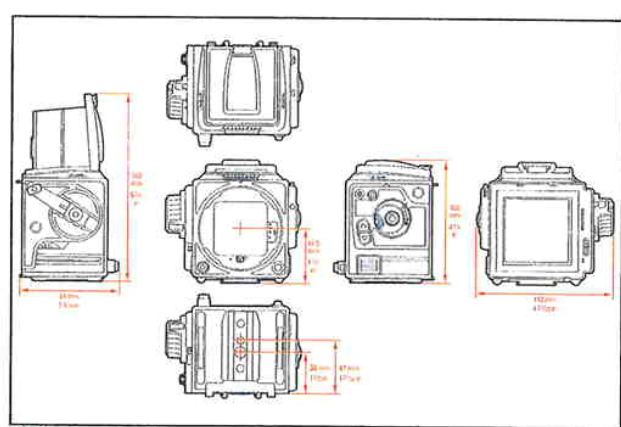
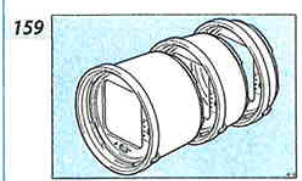
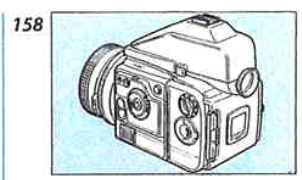
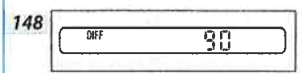
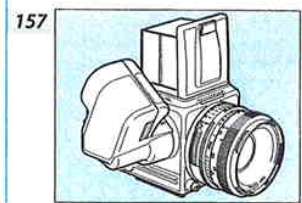
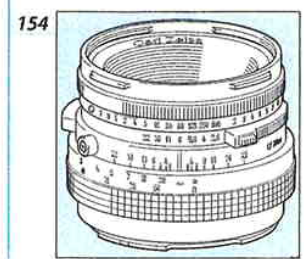
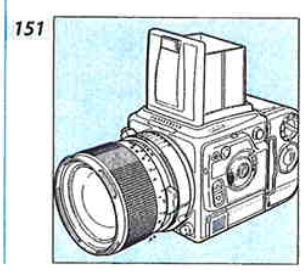
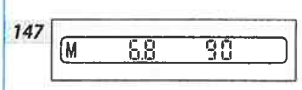
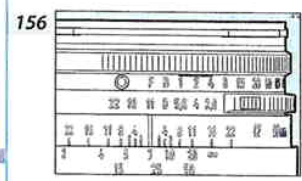
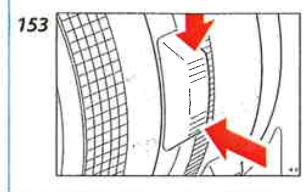
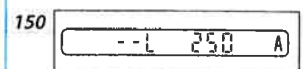
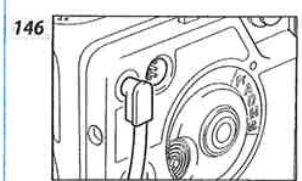
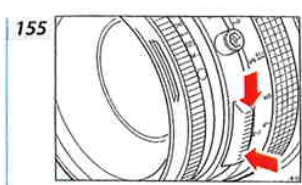
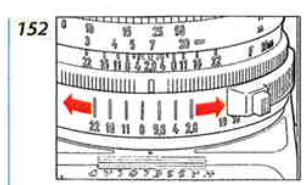
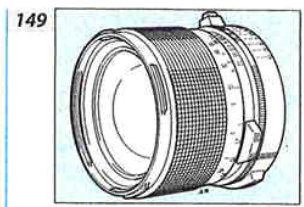
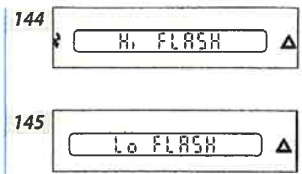

160

A
 FE50, FE80, FE110, FE60-120, FE150, FE250, FE350, 42210, 202FA, 1.4XE, 2XE, 56E, 32E, 16E, Winder, E12CC, E12, E16, E24, 41017, 51012, Pola, 70, A12, A16, A24, A32, Proshade 6093T, D-Flash 40, Battery Pack DF, 42216, 42219, 8, Variogon CF 140-280

B
 PM 5, PM 90, HM2, 41017, 51012, Proxars, Softars, 70, A12, A16, A24, A32

C
 CB60, CB80, CB160, PC-Mutar 1.4X, CF30, CF40, CF50, CF80, CF100, CF120, CF135, CF150, CF180, CF250, CF250s, CFE350, CF500, 42216, 42219, 8, Variogon CF 140-280

Hasselblad 202FA

– speed and precision

Thank you for choosing a Hasselblad 202FA. The combination of precise metering, auto-exposure and flash metering creates a sophisticated camera that remains easy and comfortable to operate. It is particularly useful in rapidly changing light conditions and for fast-moving subjects, producing superb professional image quality. With the 202FA you have a choice of either aperture priority automatic or truly manual function. In the automatic modes you can manually adjust the computer-controlled exposure within the range +5 to -5 EV. The extremely accurate focal plane shutter provides one of the widest ranges of shutter speeds in the medium format field: 34 minutes to ultra fast 1/1000 s with 1/2 stop increments in manual mode or 90 s to 1/1000 s with 1/12 stop increments in automatic mode with FE lenses. It also provides the fastest flash synch speed among medium format focal plane shutters: 1/90 s.

Primarily designed to take advantage of this remarkable shutter are the Hasselblad FE series lenses, ranging from the medium wide-angle 50 mm f/2.8 to the short telephoto f/4, including the powerful Planar 110 mm f/2. And using the Hasselblad Converter 2XE doubles the range of focal lengths at a stroke!

These outstanding lenses by produced Carl Zeiss are supported by the brightest possible view finder image, provided by the Acute-Matte D focusing screen, completed with the illuminated LCD display with all relevant exposure and set-up data.

The metering system compiles the information from the lens, the built-in exceptionally sensitive light meter, and the film speed setting on the attached E or TCC magazine to calculate the accurate shutter speed. If any of the parameters, e.g. the pre-set aperture, is changed the shutter speed changes accordingly. A Hasselblad winder is available as an optional extra to motorize your 202FA for maximum convenience.

This instruction manual describes in detail how to operate your 202FA, so please read it carefully. If you have a query do not hesitate to contact your dealer – we want you to be 100% satisfied! Your dealer can also provide you with the latest in news and technical developments from Hasselblad. A quarterly magazine – FORUM – is published with the emphasis on photographic imagery featuring photographers from all over the world to provide you with inspiration! Our internet site – <http://www.hasselblad.com> – is a source of general and technical information and you can e-mail us – info@hasselblad.se – for further inquiries.

Your new 202FA provides access to the Hasselblad potential. The realization of this potential is only dependant upon your skill, care and judgement as a photographer.

Congratulations on a fine choice!

Contents

Hasselblad 202FA Introduction Contents	11 Automatic exposure (AE) lock
6 Parts and Components	11 Adjustment buttons
8 GETTING STARTED	11 Left hand grip
8 Battery	12 OPERATING DETAILS
8 Winding the camera	12 Activating camera & metering system
8 Front protective cover	12 Focusing, exposure release and viewfinder display
8 Attaching the lens	12 Viewfinder display & symbols
8 Removing the lens	13 Double exposure
8 Rear cover MultiControl	14 Mirror and mechanism pre-release
8 Attaching the magazine	14 Selftimer
9 Removing the magazine	14 Cushioned grip
9 Magazine status indicator	14 Exposure release button
9 Opening the focusing hood	14 Cable release
9 The built-in magnifier	14 Lens catch
9 Closing the focusing hood	15 Focal plane shutter
10 Winding crank	15 Quick coupling plate
10 Removing the winding crank	15 Mode selector
10 Attaching the winding crank	16 Automatic exposure lock (AE) lock
10 Strap, attaching and removal	16 Adjustment buttons
	16 Flash connectors
	16 Display illumination
10 MAIN FEATURES	16 VIEWFINDER SYSTEM
10 Focusing screen	16 Changing the focusing hood/viewfinder
10 Exposure meter	17 Changing the magnifier
10 Viewfinder display	17 Changing the focusing screen
11 Control panel	17 LENSES
11 Flash connectors	18 FE lenses
11 PC-socket	18 Aperture
11 Dedicated flash connector	18 Focusing and depth-of-field
11 Display illumination	
11 Mode selector dial	

18 Depth-of-field scale	27 Flash set at TTL mode
18 Depth-of-field preview	28 Flash set at automatic mode
18 Infra-red (IR) photography	29 Flash set at manual mode
19 Exposure value (EV)	29 Non-dedicated flash units
19 Other Hasselblad lenses	30 How to use a non-dedicated flash unit
19 MAGAZINE OPERATION	30 THE 202FA WITH F- AND CF LENSES
19 Loading the magazine	30 F lenses
19 Step-by-step film loading	31 Flash photography with F lenses
20 Magazine load status	31 How to use a dedicated flash unit
20 Removing the film	31 Non-dedicated flash units
20 Film tab holder	31 CF lenses
20 Magazine slide pocket	31 Depth-of-field preview knob
21 Film plane index	31 F setting
21 THE METERING SYSTEM	31 CF lens in F mode and flash photography
22 OPERATING MODES	32 How to use a dedicated flash unit
22 Pr programming mode	32 ACCESSORIES
22 How to use the "Pr" mode	32 Accessory mounts
22 Setting the film speed	33 MAJOR FE ACCESSORIES
23 Setting the selftimer delay	33 Winder
23 Adjusting the automatic flash metering	33 Viewfinders
23 D - differential mode	33 E-type extension tubes
24 How to use the "D" mode	33 External battery cassette
24 A - Automatic mode	33 GENERAL ACCESSORIES
25 M - Manual mode	34 Troubleshooting
25 ML - Manual, locked	37 Technical specifications
25 Warning functions	39 Camera Care, Service and Guarantee
26 FLASH PHOTOGRAPHY	
26 Dedicated flash units	
27 Using a dedicated flash unit	

Parts & Components

1 Focusing hood cover	30 Dedicated flash connector
2 Display recess	31 Flash connector socket cover
3 Focusing screen Acute-Matte D*	32 Display illumination button
4 Focusing screen catch	33 Strap lug
5 Liquid crystal display (LCD)	34 Indicator trigger slot
6 Display illumination window	35 Film plane indicator
7 Viewfinder mirror	36 System mark
8 Shutter release button	37 Film load indicator
9 Aperture scale	38 Film holder key
10 Depth-of-field scale	39 Film speed dial
11 Interlock button (not on FE)	40 Film holder
12 Focusing ring	41 Film magazine
13 Lens front bayonet, exterior	42 Magazine slide
14 Lens front bayonet, interior	43 Film magazine catch
15 Depth-of-field preview knob	44 Magazine hook slots
16 System mark	45 Magazine gear
17 Lens mount	46 System connectors
18 Driveshaft	47 Focusing hood
19 Data bus connection bracket	48 Film winding crank
20 Lens catch	49 Magazine slide holder
21 Selftimer indicator	50 Film tab holder
22 Battery compartment	51 Magazine support slot
23 Adjustment button	52 Frame counter
24 Cushioned grip	53 Magazine support
25 Battery cassette	54 Magazine status indicator
26 Battery	55 Camera support
27 Mode selector dial	56 Quick coupling plate
28 PC socket	57 Tripod thread 1/4"
29 Automatic exposure lock, AE-lock	58 Magazine indicator trigger
	59 Data bus connectors
	60 Self timer indication
	61 Data bus connectors
	62 Lens drive shaft
	63 Lens drive shaft catch
	64 Lens bayonet plate

65 Cushioned grip	202FA CAMERA BODY, CHROME	10542
66 Mirror release / selftimer button	supplied with the following equipment:	
67 Winder coupling	Winding crank E	44086
68 Double exposure button	Focusing hood E, chrome	42317
69 Crank hub	Focusing screen Acute-Matte D 202/203	42210
70 Winding crank catch	Standard strap	59110
71 Winding crank	Front protective cover	51438
72 Winder bayonet mount	Rear cover MultiControl	51070
73 Winding crank index		
74 Strap lug	202FA CAMERA BODY, BLACK	10546
75 Magazine driving gear	supplied as 10542 above, but equipped with black Focusing hood E 42325	
76 Magnifier		
77 Shutter blind	202FA STANDARD KIT, CHROME	11099
78 Magazine hooks	Complete camera including 202FA camera body, chrome and Zeiss Planar FE 2.8/80 mm and Film magazine E12 - 6x6, chrome	
	202FA STANDARD KIT, BLACK	11101
	Complete camera including 202FA camera body, black and Zeiss Planar FE 2.8/80 mm and Film magazine E12 - 6x6, black	

*Acute-Matte designed by MIKOKITA

In the text, positions of components and orientation are described in relation to the camera as seen when taking a photograph, i.e. the lens at the front the viewfinder on top and the winding crank on the right hand side.

The appropriate illustrations are indicated by the figures beside the small headings in the text.

Getting Started

This section outlines the basic functions and operations of the Hasselblad 202FA. More detailed information can be found in later sections.

Battery

The battery compartment and cassette is located in the lower forward corner on the left hand side of the camera body. Pull out the cassette and install the battery - 6V type PX28L or equivalent - according to the marking on the cassette. Push the cassette all the way back into the compartment.

Winding the camera

After inserting the battery, wind the camera by rotating the winding crank on the right hand side clockwise one complete turn until it locks. If it will not turn then it is locked which means that the camera is already wound.

Front protective cover

Turn the cover (bayonet fitting) in the direction of the arrow in the illustration and lift it out. Do not remove it until you are ready to attach a lens.

Attaching the lens

Remove the lens' rear protective cover by rotating it counter-clockwise and lifting it off the lens.

Check that both the camera and the lens are wound. Fig 5 shows the proper position against the index marks for the camera drive shaft (top) and the lens drive shaft (bottom). If the lens is not wound you can insert a coin or a

similar object in the slot and turn the shaft in the direction of the arrow approximately $\frac{1}{4}$ of a full turn. You may find that holding the camera body in your left hand and the lens in your right hand as shown in the illustration (top, right) is the easiest way to attach the lens. When you have aligned the red index on the lens with that on the camera body as shown in the illustration, the lens will fit easily into the bayonet mount. You can then rotate it clockwise until it stops with a faint click as the lens locks in place.

Removing the lens

Depress the lens release button, rotate the lens counter-clockwise and lift it out of the bayonet mount.

⚠ You can only attach and remove the lens when the camera is fully wound and not in pre-released mode (see 'pre-release and cable release').

Rear cover MultiControl

Depress the catch, tilt the cover backwards, and lift off. Do not remove it until you are ready to attach a magazine.

⚠ Always keep the Rear cover MultiControl or a magazine in place to protect the shutter.

Attaching the magazine

Ensure that the magazine slide is fully inserted with hinge toward the front of the camera and that the magazine status indicator is white. If the indicator is red, then see 'Magazine status indicator'. It is also advisable to have the camera fully wound. Rest the magazine on the magazine supports with the support lugs properly en-

gaging the recesses. Carefully swing the magazine towards the camera body, checking that the camera's upper support hooks fit into the slots in the magazine. Push the magazine gently but firmly against the hooks while sliding the magazine catch to the right. Release the button when the magazine has made contact with the camera body and then push the button to the left to ensure that it has reached the locked position. Remove the slide to positively lock the magazine to the camera body. The camera is now ready to use.

Removing the magazine

Removing the magazine is simply the reverse of the attaching procedure. It is advisable to have the camera fully wound and the magazine status indicator displaying white. Insert the magazine slide fully and with the hinge towards the front of the camera. Slide the magazine catch to the right, tilt the magazine back and lift it off the lower supports.

⚠ The magazine cannot be removed without inserting the magazine slide. The slide protects the film from fogging.

⚠ Ensure that the slide is pushed all the way into the magazine.

⚠ Note also that the camera cannot be operated when a magazine, with the slide inserted, is attached to the camera.

The magazine status indicator

The status indicator on the right hand side of the magazine shows white when the magazine is ready to operate and red when the film has not been advanced after an

exposure. If the status indicator shows red, release the camera first before attaching the magazine. Then, winding the camera again will automatically advance the film by one frame.

⚠ Do not attach a magazine showing white to a camera that is not rewound! Wind the camera first or you will lose a frame.

⚠ Do not attach a magazine showing red to a fully wound camera! This could result in a double exposure.

Opening the focusing hood

Lift the lid with a firm grip on the tab at its rear edge and swing it up to a vertical position. The hood unfolds automatically and locks in open position.

The built-in magnifier

The magnifier flips up into the viewing position when the oval button inside the lid is moved to the right, as in the illustration.

To fold the magnifier down simply press it back down towards the lid until it locks into place.

It can easily be exchanged to suit individual eyesight (see 'Changing the magnifier').

Closing the focusing hood

Fold away the magnifier by pressing it back down towards the lid until it locks into place. 'Pinch' in the side plates at the hinge points and then push the lid lightly backwards. The hood then automatically folds back down.

8

The winding crank

One full revolution of the winding crank winds the camera, cocks the lens mechanism and transports the film to the next frame. Underneath the crank are the drive shaft and the bayonet mount for the Hasselblad Winder, which can be attached after removing the crank. It is recommended that the camera is fully wound when the crank is removed or replaced.

Removing the winding crank

To remove the crank push the catch lever on the rear of the crank hub downwards while rotating the crank counter-clockwise. Then pull it straight out from the shaft.

Attaching the winding crank

Attach the crank to the shaft, aligning the smaller triangular index mark against the red dot just above the mount. Keep the crank pushed against the camera while turning it clockwise until the larger triangular mark is aligned with the red dot.

Strap

The 202FA is delivered with a medium wide shoulder strap, packed separately. You will find other types of straps in the Hasselblad Product Catalogue. All straps are provided with special clips for easy attaching and removing of the strap.

STRAP ATTACHMENT

Place the main body of the strap clip from behind over the strap lug on the camera with the strap pointing backwards. Press the tip of the clip towards the camera while pulling the strap to slide the clip over the lug to the locked position.

STRAP REMOVAL

Hold the strap pointing backwards and lift the locking plate of the clip high enough to pass over the top of the lug. Push the clip forwards to slide it off the lug.

Main features

This section is a brief overview of the main features. Each feature is described in detail later on in the manual. See under relevant headings.

Focusing screen

The 202FA is fitted with a focusing screen Acute-Matte D for unrivalled brightness and sharpness. A circle of dots indicates the metering area used by the built-in selective meter.

The screen can easily be exchanged for others specially designed for various applications (see 'Changing the focusing screen').

Exposure meter

The exposure meter is a centre-weighted selective meter where the metered value is measured over a circular Ø28 mm central area which is approximately 20% of the total image area.

The viewfinder display

The viewfinder display - the information centre of the camera - is located above the upper edge of the viewfinder image. You will find a comprehensive description of the display and its symbols in a later section.

automatically 16 seconds after the last key or button operation, but all relevant data is stored in the memory.

Focusing, exposure release and viewfinder display

Turn the focusing ring until the image of the subject appears sharp in the viewfinder. Depress the exposure button half-way in to the pressure point.

If the mode selector dial is set at the D or A position the display now shows - besides a few other symbols described in a following section - the shutter speed calculated as a result of the preselected aperture and film sensitivity. With the mode selector set at M the display shows the letter M, the pre-selected aperture and the shutter speed set on the shutter speed ring. If the exposure button is released again, the display instead shows the selected shutter speed and the difference in EV between the metered and the manually set values.

You can now press the exposure button all the way in to make the exposure. After releasing the button, rotate the winding crank one full turn until it locks, to rewind the camera and advance the film one frame.

However, you do not need to release the pressure on the release button to wind on if you wish to make a rapid series. You can instead keep the button depressed and wind on after every exposure.

Viewfinder display and symbols

Fig. 34 depicts the actual view of the display as seen without a prism viewfinder. When a prism viewfinder is used the position of the symbols becomes reversed, but the microprocessor adjusts their appearance to make them fully readable.

The control panel

The control panel occupies most of the left hand side of the camera body. It includes all the controls for the various functions of the 202FA, such as:

- The flash connectors
- The display illumination switch
- The mode selector dial
- The adjustment buttons

Flash connectors

The flash connectors are located underneath the protective cover in the upper forward corner of the control panel. The smaller one is a standard PC-socket and the larger one is a 6-pin connector for TTL-controlled dedicated flash units.

The PC-socket

Non-dedicated flash units and SCA adapters should be connected to this socket.

The dedicated flash connector

A dedicated flash unit connected to this 6-pin outlet directly or through a suitable adapter is fully controlled by the camera processor. You will find detailed information on flash photography in later sections.

The display illumination

Pressing the button above the flash connectors turns the display illumination on or off. The switch has a toggle function (press once for 'on' and once again for 'off'). It works only when the camera is activated.

Flash ready signal

The flash symbol is illuminated green when a dedicated flash is connected, turned on and ready to be fired.

Manual mode

The mode selector dial is set at M.

Selftimer function

Flashes when the selftimer is activated. Appears also by programming the selftimer delay in Pr mode.

Differential mode

The mode selector dial is set at D.

Plus / minus sign

Appears together with a correction or deviation value when the mode selector dial is set at D, A, or M and in certain Pr functions. The right hand plus/minus sign can also be displayed together with the 'Flash ready signal'.

Figures

Eight 7-segment figures indicate corrections, deviations, EV, shutter speed, aperture and certain other information in operation modes D, A and M as well as programming functions in Pr mode and certain warnings in various modes of operation.

Fraction of operation

One or two dashes to the right of the figure indicate $\frac{1}{3}$ and $\frac{2}{3}$ step higher value than indicated by the figure.

Minutes indication

A vertical dash to the right of the figure indicates that the preceding figure shows the number of minutes at shutter speeds of 60 s or slower.

The mode selector dial

With the mode selector dial you can select any of the five operating modes Pr, A, D, M or Mt available on the 202FA. The A, D, M and Mt are used for photography and Pr for the programming of certain functions.

The automatic exposure (AE) lock

In the centre of the mode selector dial is a push-button, marked with a red circle. It operates the AE-lock and certain other functions, depending on the setting of the mode selector dial. You can also use it to start the electronic operating system in the camera.

The adjustment buttons

These keys also have multiple functions depending on the setting of the mode selector dial.

⚠ The functions of the mode selector dial, the AE-lock and the adjustment buttons are described in detail in later sections.

Left hand grip

You may find that holding the 202FA in your left hand with your index finger on the release button, as shown in the upper illustration below, is the most convenient grip. You can reach the AE-lock and the adjustment keys with your left thumb (see illustration) and your right hand is free for focusing, aperture setting, operating the crank or changing the lens or the magazine.

Operating details

Assuming a fresh battery is in place and a lens and film magazine are attached to the camera, you can go through the following procedures step-by-step to become familiar with operating details.

Activating the camera and metering system

Before you operate the 202FA you have to wind the camera to cock the shutter (if it is released) and switch on the metering system. To be able to release the camera you also have to remove the magazine slide.

The fully wound 202FA can be switched on in two different ways:

1. By depressing the exposure button halfway in, i.e. to the 'pressure point'.
2. By depressing the AE-lock button.

Activation as in (1) above can only be performed when the magazine slide has been removed. At normal light levels this activation occurs when the exposure button is depressed for an exposure.

⚠ At low light levels the camera should be activated a few seconds before releasing the exposure in one of the automatic modes.

Activation as in (2) is not possible if the AE-lock has been kept depressed for more than 16 seconds.

Keep the magazine slide inserted to avoid unwanted battery power consumption caused by unintentional activation of the metering system.

The electronic system and the viewfinder display turn off

Flash ready signal

The flash symbol is illuminated green when a dedicated flash is connected, turned on and ready to be fired.

Manual mode

The mode selector dial is set at M.

Selftimer function

Flashes when the selftimer is activated. Appears also by programming the selftimer delay in Pr mode.

Differential mode

The mode selector dial is set at D.

Plus / minus sign

Appears together with a correction or deviation value when the mode selector dial is set at D, A, or M and in certain Pr functions. The right hand plus/minus sign can also be displayed together with the 'Flash ready signal'.

Figures

Eight 7-segment figures indicate corrections, deviations, EV, shutter speed, aperture and certain other information in operation modes D, A and M as well as programming functions in Pr mode and certain warnings in various modes of operation.

Fraction of operation

One or two dashes to the right of the figure indicate $\frac{1}{3}$ and $\frac{2}{3}$ step higher value than indicated by the figure.

Minutes indication

A vertical dash to the right of the figure indicates that the preceding figure shows the number of minutes at shutter speeds of 60 s or slower.

Film speed

Indicates film speed set on E-magazine (or 'TCC - dial' or inserted manually in Pr mode (see later section) S in ISO is also used to indicate seconds at very slow shutter speeds (0.7 s to 60 s) or long exposures (1 min 30 s to 34 min).

Battery check

Appears when battery capacity is low (see 'warning functions').

Magazine check

Indicates that the attached magazine is not an E (or 'TCC - magazine).

Automatic mode

Indicates that the mode selector dial is set at A.

Warning symbol

Flashes red together with one or more of the other symbols to indicate various problems.

The right hand side

On the right hand side of the camera body are the winding crank, the pre-release (to lift the mirror) and selftimer lever.

Double exposure

You can make double (or multiple) exposures by rewinding the camera without advancing the film. This is possible by depressing the double exposure button in the centre of the crank hub and simultaneously turning the crank slightly clockwise. Then you can release the button and complete the winding until the crank locks.

12

9

11

13

Mirror and mechanism pre-release

By pre-releasing certain camera functions and lifting up the mirror you can avoid camera vibrations, reduce the sound level and shorten the time delay between the depressing of the exposure button and shutter release. Pre-releasing is done by sliding the pre-release lever *once*. To reset the mechanism and lower the mirror again you perform the operation for a double exposure as described above.

⚠ Since the mirror is lifted the light metering is interrupted and locked on the last recorded value

The selftimer

Pressing the pre-release lever a *second* time starts the selftimer function. This is indicated by the selftimer symbol in the viewfinder display and by a flashing red light on the camera body to the left of the lens mount. The standard delay in the selftimer is 10s but it can be set at intervals between 2s and 60s in the Pr mode. At the beginning of the delay the light flashes twice per second, but when two seconds remain of the delay time it increases to four times per second and changes to a continuous light during the last half second. You can interrupt the selftimer function at any time by pressing the pre-release lever again or by a 'blind' rewind as for double exposure.

The selftimer function is inoperative when the shutter speed is set at B.

The cushioned grip

A rubber cushion along the lower edge of the right hand side provides a safe and comfortable grip.

14

D: Differential mode

M: Manual mode

ML: Manual (locked shutter speed)

The functions of these modes are described in detail later.

The automatic exposure (AE) lock

The AE-lock is the push-button in the centre of the mode selector dial, marked with a red ring. It has different functions, depending on the modes of operation as described later. It can also be used to activate the camera's metering system except after the AE-lock has been depressed for more than 16 seconds, e.g. if the camera has been laying on the left hand side. In that case the camera can only be activated for normal use by depressing the exposure release button to the pressure point.

The adjustment buttons

The adjustment buttons also have different functions depending on the selected mode. With a few exceptions a single push on the upper button increases and on the lower button decreases the value to be adjusted. If you keep the button depressed for more than half a second the value starts to change at a rate of 4 – 5 steps per second until the button is released.

The flash connectors

The larger six-pin TTL-connector provides automatic control of dedicated flash units. The Hasselblad D-Flash 40 can be connected directly to the 202FA but other dedicated flash units will require a suitable adapter, such as the Hasselblad SCA-adapter 390, between the unit and the camera. The smaller connector is a common PC socket for any kind of flash unit. You can find further instructions on flash photography in a later section.

16

Lenses

Hasselblad lenses made since 1957 can be separated in two major groups, each with two sub-groups:

Lenses with a built-in leaf shutter:

C lenses and CF lenses

Lenses without shutter:

F lenses and FE lenses

CF, F and FE lenses can be used on the 202FA, but only the FE lenses will give you access to the full range of exclusive and sophisticated features of the 202FA. FE lenses are mentioned here first as it is assumed this will be the main type of lens used.

⚠ The built-in leaf shutters of C and CF lenses cannot be used when fitted to a 202FA. Please see specific sections later in this manual about using these lenses.

FE Lenses

The Hasselblad FE lenses, which have no built-in shutter, can easily be identified by their system sign, i.e. the double blue lines on the left hand side of the aperture ring. Another sign, visible only when the lens is detached from the camera body, are the four data-bus contact pins in the bayonet plate at the rear of the lens. They are used for the data transmission between the lens electronics and the electronic system in the camera body. The contact surfaces of these pins are sensitive to contamination and should not be touched with your fingers. Attach the protective cover after removing the lens from the camera and never set the lens down on the unprotected bayonet plate.

18

The front

Exposure release button

In the lower right hand corner at the front, within comfortable reach of the left hand grip, is the exposure release button. The button has four different functions:

When depressed to the "pressure point" it:

1. activates the camera.
2. changes the display to indicate aperture and shutter speed.
3. locks the light value in A mode.
4. releases the shutter to make the exposure with preset or calculated values.

⚠ The exposure button is locked when the magazine slide is in the magazine.

Cable release

When using shutter speeds slower than 1/30s it is recommended that you mount the camera on a tripod or support. Use a cable release too, screwed into the threaded mount in the centre of the exposure release button. The exposure button retains its functions with a cable release attached.

Lens catch

The lens catch button is located on the lower left hand of the camera front. To release and remove the lens you have to keep the button depressed while rotating the lens clockwise as seen from behind.

Display illumination

In low light levels depressing the switch button on the upper edge of the control panel switches on the illumination of the viewfinder display. The button has a toggle function.

The Viewfinder System

The 202FA has an integral viewfinder system comprising a focusing screen Acute-Matte D for the optimum in resolution and brightness providing a through-the-lens laterally reversed image. The supplied focusing hood is light, compact and foldable for maximum convenience and provides protection for the focusing screen. It is supplied with a 4x magnifier for precise focusing.

There is a selection of focusing screens to choose from for special needs, all rapidly and easily changeable. A range of viewfinders is also available, featuring angled viewing capabilities, prisms and metering facilities. See fig. 162 for availability and the Hasselblad Product Catalogue for further details.

Changing the focusing hood or viewfinder

To remove the focusing hood for using any other viewfinder within the TCC system detach the magazine (or the Rear cover MultiControl). Also fold down the fo-

Setting the aperture

The aperture ring is the one closest to the camera body. Use it to pre-set the selected f-stop. The full f stops marked on the ring have click stops, but there are also click stops for each intermediate half f-stop. The set aperture value can be read against the heavy index line on the grooved ring in front of the aperture ring. It will also show on the viewfinder display when you depress the exposure button halfway in, i.e. to the pressure point. The aperture ring has two grooved grips for handling convenience. One of these grips has a push-button which has no function on the 202FA.

Focusing and depth-of-field

The focusing ring is the rotating ring with a knurled rubber grip closest to the front of the lens. It has two scales for the focusing distance, the white metre scale and the orange inch/foot scale. Rotate the focusing ring until the image of your subject appears absolutely sharp on the focusing screen.

The depth-of-field scale

The depth-of-field scale repeats the aperture values on both sides of the heavier index line between the fixed ring with the index line and the focusing ring. When the image is focused on the screen you can read the focusing distance opposite the index line in the depth-of-field scale. The depth-of-field limits can be read opposite the left and right values corresponding to the pre-set aperture value. The illustration depicts the depth-of-field for the pre-set aperture value of f/8.

Depth-of-field preview

The lens is normally set at the largest aperture to provide

The rear

The focal plane shutter

The opening in the rear of the camera is normally covered by the shutter blinds. The 202FA has a mechanically-powered, electronically-controlled focal-plane shutter with two textile blinds running from left to right across the opening. The running time for the blinds is 1/90s. In all modes except M, the shutter speeds are calculated by the metering system which controls the shutter. The shutter speeds are adjusted in increments of 1/2 EV-step in the interval from 1/1000s to 16s and 1/4 EV step in the interval from 16 1/4s to 90s, but for practical reasons only the shutter speed for each 1/2 EV-step is indicated in the viewfinder display.

⚠ Whether the shutter is wound or released, one shutter blind is always exposed in the opening. Take utmost care when handling the camera when neither the Rear cover MultiControl nor a magazine is in place as the blinds are vulnerable to damage.

To the right of the opening are the magazine driving gear and the trigger for the magazine status indicator. There are also the contact pins for the data bus connection between the magazine and the central processor in the camera body. The contact pins are sensitive to contamination and should not be touched. At the lower edge of the back are the magazine supports and towards the top are the magazine hooks - both together serving to positively fix the magazine to the camera body.

cusing hood to avoid damaging it. Remove the hood by sliding it to the rear in its guide slots. Slide the replacement viewfinder into the slots and push it forward until it stops. When fully inserted the viewfinder is retained in position by a spring-loaded ball latch until you have re-attached the magazine or the rear cover.

Changing the magnifier

The standard 4.5x magnifier lens plate can be changed for a plate with a correction lens to compensate for individual eyesight. The supplied magnifier marked -1 provides comfortable viewing of the focusing screen and the display for most users. Correction lenses, however, are available with powers ranging from +3 to -4 dioptres. Change the magnifier as follows:

1. Remove the focusing hood from the camera body and open it by lifting the lid.
2. Release the magnifier by pushing the catch to the left. Push the magnifier halfway down and pull out the lens plate.
3. Keep the plate holder halfway down and insert the replacement lens plate with the printed side up. Fold the hood and put it back on the camera.

Changing the focusing screen

Your 202FA is equipped with the exceptionally bright and sharp focusing screen Acute-Matte D. The area inside the dotted circle indicates the area measured by the built-in exposure meter. If you wish to replace the focusing screen with any of the other focusing screens in the Hasselblad system, simply follow the procedure below:

1. Detach the magazine and the viewfinder.
2. Push the two screen catches to the side into their recesses.

the brightest possible viewfinder image with the shallowest depth-of-field. You can stop down the lens diaphragm to the pre-set aperture by pushing down the diaphragm preview knob until it locks. To re-open the diaphragm, depress the lower end of the knob.

Infrared (IR) photography

Infrared light with wavelengths beyond 800 nm are reflected by the lens to an image plane further away from the lens than the image plane for visible light. When photographing with IR light you have to compensate for this difference by setting the focusing distance at the red IR index to the right of the common index line. Proceed as follows:

1. Focus as usual on the focusing screen.
2. Mark or memorise the distance on the focusing scale opposite the common index line.
3. Rotate the focusing ring to set this distance opposite the IR index.

Exposure value (EV)

The orange scale on the right hand side indicates the exposure value for the set aperture/shutter speed combination. The scale has no particular function on 202FA. Do not confuse the exposure value with the light value stored in the metering system when you depress and release the AE-lock.

Other Hasselblad lenses

The use of other Hasselblad lenses with your 202FA is described in a later section.

The underside

Quick-coupling plate

On the underside of the camera are the quick-coupling plate, the tripod thread and the two supports that steady the camera when placed on a flat surface. The quick-coupling plate fits the Hasselblad accessories, such as the tripod quick-coupling and the flash bracket. The tripod thread is 1/4".

The top

The viewing components occupy most of the camera top. The camera body is supplied with the collapsible focusing hood, which also serves as a protective cover for the focusing screen. In front of the 'Hasselblad' sign is a window for daylight illumination of the viewfinder display screen.

The left hand side

The mode system provides you with the maximum in exposure control. It is not only convenient but also versatile producing a variety of working methods for a variety of situations in a completely dependable manner.

The mode selector dial

The mode selector dial is in the centre of the control panel on the left hand side. To select any of the operating modes of the 202FA simply turn the dial until the symbol for that particular mode is aligned with the red index mark. The different operating modes are:

Pr: Programming mode

A: Automatic mode

3. Place your hand over the screen and invert the camera. The screen should now drop into your hand.

(Should the screen refuse to drop out by itself, ensure that the camera is fully wound, remove the lens and check that the mirror is in the down position. Put a finger through the lens mount and push gently at the screen from underneath, preferably with a soft cloth between the finger and the screen.)

4. Insert the replacement screen with the smooth side up and the sharp-edged corners down. Ensure that all four corners of the screen are positively seated on their supports. You need not return the screen catches. This is done automatically when the viewfinder is replaced.

⚠ Always avoid allowing direct light to enter the viewfinder eyepiece when making an exposure.

Magazine Operation

Hasselblad film magazines provide the opportunity to vary format, length and type of film used. They can be quickly and easily switched mid-film without the loss of a single frame.

The following description applies to A- and E-type magazines. E-type magazines have the additional feature of a film speed setting dial. The information is automatically transferred to the camera's metering system via the databus connections.

Operation of the magazines is not difficult but pay particular attention to the section on loading. Go through the procedure one step at a time and practice a little until you feel confident. Note especially which way round the spool of film is placed and the positioning of the backing paper under the clamp bar.

The film is automatically advanced frame-by-frame in the magazine by the camera winding mechanism and consequently only when attached to the camera body. Therefore when separated, the magazine and camera body could become unmatched. This can be determined by checking the magazine status indicator or by the winding crank status.

Try to adopt a routine that suits you regarding winding and removal as well as checking on the status of each item. This will ensure that the camera/lens/magazine combination status is always fully operative.

15

17

19

Loading the magazine

The magazine can be loaded on, or off the camera. If it is to be loaded off the camera, then the magazine slide must be inserted first.

In either case, when inserting the slide ensure that its flat side is towards the rear (see detail in illustration) as this facilitates the removal of the film holder.

Step-by-step film loading

Follow the procedure below in the correct order.

- 62 Fold out the film holder key.
- 63 Turn the key counter-clockwise and withdraw the film holder (magazine insert).
- 64 Place an empty take-up spool under the grooved knob of the spool clamp bar. Insert a roll of film under the other end of the bar, turned the same way as in the illustration. Be sure to remove all of the paper band surrounding a new roll of film.
- 65 Turn the film holder key clockwise to open the film clamp. Pull 8-10 cm (3-4 in.) of paper backing off the film roll and slide the edge under the clamp.
- 66 Insert the tongue of the backing paper into the slot in the take-up spool.
- 67 Turn the grooved knob clockwise until the arrow on the paper backing is aligned opposite the triangular index on the spool clamp bar, but no further.
- 68 Turn the film holder key counter-clockwise and insert the film holder into the magazine. Ensure that it is correctly positioned. Turn the film holder key clockwise to lock the film holder in the magazine and then fold the key back into place.
- 69 Fold out the film crank and rotate it clockwise about ten turns until it stops. Then turn it counter-

clockwise and fold it in. The figure (1) will now be displayed in the automatic frame-counter window indicating that the magazine is loaded and ready for use.

- The magazine's film winding crank is only blocked at frame 1. A partially exposed film may be wound off at any frame afterwards.
- Do not put the film holder down on an unclean surface or where it can attract dust.
- Clean out the magazine housing regularly removing not only dust and particles but also any scraps of paper from previous rolls that may have remained inside.
- Each magazine housing and film holder form a carefully matched pair. Be careful, therefore, when loading more than one magazine at a time not to switch housings and holders. The last three figures of the housing serial number should correspond with the serial number on the film holder.
- Load and unload the magazine away from direct light sources.

Magazine load status

In the centre of the film holder key there is a crescent-shaped indicator window that shows white when the magazine is freshly loaded. It gradually changes to red as the film is used up through. An all red indicator shows that the film is used up or that the magazine is empty.

Removing the film

After the last frame has been exposed and the film advanced, the magazine blocks the camera against further release. To remove the exposed film fold out the film winding crank and rotate it clockwise until you can feel that the film is leaving the supply spool. Withdraw the film holder from the magazine and remove the film.

Operating Modes

The different operating modes are described in the order they appear on the Mode Selector Dial.

Pr programming mode

The Pr mode is not an exposure mode but used to enter certain user defined values, different from the standard settings, which are built into the camera. The standard settings are always set when you activate the system after the battery has been removed or if no other values are stored from previous operations. Any change made in the Pr mode is effective until changed again or until the battery is removed.

The Pr mode is not intended to be used while photographing. If you make an exposure with the camera in Pr mode, the camera automatically shifts to A mode and then immediately back to Pr mode after the exposure.

After a battery change the system always returns to the standard settings and all previously entered values are lost.

Pr1

To set the film speed when you are using standard film magazines. Speed values can be set from 12/12° ISO to 6400/39° ISO in 1/3 EV step (1° ISO) increments. The standard setting is 100/21° ISO.

Pr2

To set the selftimer delay in the range from 2 seconds to 60 seconds. The available values are: 2, 4, 6, 8, 10, 12, 14,

How to use the "D" mode

The differential D Mode is very useful when light conditions are stable enough to take several different meter readings in order to calculate the final exposure. The contrast range of a subject can also be checked in this manner. By locking and storing the light values on one part of the subject and then moving the metering area to another, the display continuously shows the contrast difference between the initially metered part and the present location of the metering area. The stored light value remains for any number of exposures until intentionally replaced or adjusted.

Suggested procedure:

1. Pre-set the film speed. With an E- (or TCC-) magazine set the film speed dial. With a standard magazine use the Pr mode to insert and store the film speed.
2. Pre-set the desired aperture.
3. Set the mode selector dial at D and aim the camera to place the metering area over a selected part of the subject.
4. Depress the AE-lock button to start the metering system. The viewfinder display shows the symbol "DIFF", the figure "0" and the shutter speed (calculated from the pre-set aperture, the ISO setting and the metered light level) continuously changing the speed as the metering area is moved - to brighter or darker subject parts.
5. Release the AE-lock button to lock the exposure value and the shutter speed on a selected "reference" part of the subject considered to have the desired "normal" brightness. As the metering area is moved to other areas the display continuously shows the brightness difference in + or - EV between the reference area and the present location of the metering area with an accuracy of 1/3 EV-step.

Film tab holder

The end tab of the film pack can be inserted in the holder on the back of the magazine as a reminder of the kind of film that has been loaded into the magazine.

Film speed dial (E-type magazine)

On the left hand side of the magazine above the film holder key is the film speed dial. The speed set on this dial is automatically transferred to the metering system in the camera body and displayed in the viewfinder in the Pr mode. The range of the film speed dial extends from ISO 12 to ISO 6400 with 1/3 and 2/3 intermediate settings.

Magazine slide holder

On the rear of the magazine is the slide holder where the magazine slide can be kept when not in use. Turn the slide with the hinge towards the rear to fold the bow fully into the slide holder recesses.

Film plane index

Close to the magazine front and moulded into the rubber grip cushion is the film plane index. It can be used to measure the subject-to-film distance when the exact figure is required, e.g. in close-up photography.

16, 20, 30, 40, 50, 60 seconds. The standard setting is 10 seconds.

Pr3

To adjust the automatic flash metering function, facilitating the use of fill-in flash.

The setting range is -3 to +1 EV in 1/3 EV increments. The standard setting is 0.

How to use the "Pr" Mode

The programming Pr mode can be selected at any time to change the standard values for film sensitivity, flash, etc. or to change previously made settings. The changed values are effective as soon as they are entered. By repeatedly pressing the AE-lock button you can shift through the Pr-functions in the sequence Pr1->Pr2->Pr3->Pr1->etc. The sequence always starts on the last used function except after a battery change. In Pr mode the camera can be started by depressing either the exposure release button to the pressure point or the AE-lock button.

Setting the film speed (Pr1 function)

Setting the film speed in Pr mode is possible only when an A-magazine is used. This is indicated on the display by the symbol "Pr" before the film speed value. With an E-magazine the film speed is set on the magazine dial, the Pr1 function is inactive and the display shows the magazine dial setting only.

1. Set the mode selector dial in the Pr position.
2. Depress the AE-lock button to start the camera and then repeatedly if required to select the Pr1 function.
3. Press the adjustment buttons to change the film speed

6. Use the adjustment buttons to adjust the exposure up or down to the desired level with 1/3 EV increments. You can display the pre-set aperture by depressing the exposure release button to the pressure point, and you can change it if required. The shutter speed adjusts automatically to the new aperture setting, keeping the exposure unchanged.
7. Depress the exposure release button fully to make an exposure.
8. Rewind the camera to cock the shutter and advance the film to the next frame with the previous exposure values and adjustments maintained.

The metering system can also be started by depressing the exposure release button. It then recalls the latest stored exposure value including any adjustments.

All settings remain unchanged until they are erased and the system unlocked by depressing the AE-lock button or by removing the battery.

A - Automatic mode

Automatic exposure with aperture priority, pre-selected film speed and automatically calculated shutter speed.

- Continuous metering of the light value.
- Locking and storing of the light value at a selected moment by keeping the exposure button at the pressure point.
- Permanent adjustment of the continuous or stored light value +5 EV-steps in 1/3 step increments.

The Metering system

An earlier section described the various operating modes of the 202FA, including the different controls on the control panel and how to use them. This section describes in detail the metering system and the different operating modes.

The metering system

See earlier section for a description of the different methods used to activate the camera and metering system. The system turns off automatically 16 seconds after the last button operation to save the batteries but all the important information remains stored in the memory and returns when the camera is re-activated.

The selective light meter is the most important feature in the metering system. The metering area is indicated by a circle of dots in the centre of the focusing screen. The circle has a diameter of 28 mm which is approximately 20% of the total image area.

The meter is very sensitive and accurate. It measures the light reflected from the subject within the metering area, applying a centre-weighted integral method. This means that light from outside that area has very little effect. Owing to its sensitivity and accuracy, minor changes of the metering area may result in significant changes in exposure values.

Like all other reflection exposure meters the selective meter is adjusted to provide an exposure value that would result in an "18% grey tone" - the photographic standard mid-tone, completely regardless of colour or apparent tonal

value. The upper button increases and the lower decreases the value in steps of 1/3 EV.

4. Reset the Mode Selector Dial to the desired exposure mode or press the AE-lock button to switch to next Pr-function.

A film speed value manually inserted in the Pr1 function is stored until changed again by the same procedure (or until the battery is removed).

If an E- (or TCC-) magazine is attached the film speed set on the magazine dial overrides the stored value. When the magazine is detached the stored value is automatically recalled. Thus it is easy to shift between E-magazines and A-magazines with films of different speeds (e.g. Polaroid films).

Setting the selftimer delay (Pr2 function)

1. Set the mode selector dial in the Pr position.
2. Depress the AE-lock button to start the camera and then repeatedly if required to select the Pr2 function.
3. Press the adjustment buttons to change the selftimer delay. The upper button increases the delay and the lower button decreases it with the predetermined steps.
4. Reset the mode selector dial to the desired exposure mode or press the AE-lock button to switch to next Pr-function.

Adjusting the automatic flash metering (Pr3 function)

The function is used to introduce a fixed adjustment in the automatic flash control to reduce or increase the flash power, e.g. for fill-in flash applications.

M - Manual mode

Normal exposure.

Functions:

- Manual pre-setting of aperture as well as shutter speed.

Features:

- Completely manually controlled exposure.
- Continuous metering of the light value.
- Continuous indication of the difference in EV between the pre-set exposure and the exposure calculated by the camera's CPU.

How to use the "M" mode

The M mode is completely manual. The metering system is working, but it does not change the shutter speed (the aperture is always pre-set manually). The display indicates the calculated "normal" exposure for the metered subject part, but the exposure will be executed according to the manual settings made.

Suggested procedure:

1. Pre-set the film speed with the film speed dial on the E- (or TCC-) magazine or using the Pr mode with a standard magazine. (This point may be omitted but is required for a correct indication on the viewfinder display).
2. Set the Mode Selector Dial to M.
3. Set the aperture.
4. Depress the exposure release or the pre-release button to the pressure point. The metering system starts and the viewfinder display shows the symbol "M" for Manual mode and the pre-set aperture and shutter speed.
5. Release the exposure button. Instead of the aperture value the display starts showing the difference in EV-

value of the subject. If the metered area is brighter or darker than this 18% grey, the exposure has to be adjusted manually up or down to 'place' this area on the correct part of the grey scale.

The value that is stored in the metering system is the "light value". This means that the shutter speed calculated by the system is adjusted automatically if the pre-set aperture or the film speed is changed. The working shutter speed is adjusted in 1/12 alt. 1/4 EV-steps, i.e. much more accurate than the half speed steps that for practical reasons are used on the viewfinder display.

Other concepts used in this manual are continuous metering and continuous indication. This means that the system continuously meters the light from the part of the subject which at that very moment lies within the metering area and also continuously updates the value displayed in the view finder. Flashing numbers or symbols in the view finder indicate that a warning function has been triggered. See section about warnings!

Pre-releasing the camera in any of the operating modes always locks the light value that is present at the moment of lifting the mirror.

In the illustrations changing indications are noted with grey symbols and flashing indications by rays around the symbol.

1. Set the mode selector dial in the Pr position.
2. Depress the AE-lock button to start the camera and then repeatedly if required to select the Pr3 function.
3. Press the adjustment buttons to set the desired correction value within the -3 to +1 EV range. Pressing the upper button increases the value and pressing the lower button decreases the value.
4. Reset the mode selector dial to the desired exposure mode or press the AE-lock button to switch to next Pr-function.

Take care that the set film speed combined with the set adjustment would not produce a result that would be outside of the flash sensitivity limits (ISO 25-1000). For example, a film speed of ISO 400 combined with an adjustment of -2 EV would result in the equivalent of an ISO1600 setting which is beyond the upper flash limit of ISO1000.

D - Differential mode

Functions:

- Automatic exposure with aperture priority, pre-selected film speed and calculated shutter speed.

Features:

- Continuous metering of the light value.
- Locking and storing of the light value at a selected moment.
- Continuous indication of the difference between the stored and the presently metered light value.
- Adjustment of the stored light value +5 EV steps in 1/3 EV-step increments.

steps between the set exposure and the calculated "normal" exposure for the present subject part with an accuracy of 1/3 EV-step, continuously changing the indication as the metering area is moved about the subject.

6. Depress the exposure release button for an exposure with the set values, independent of the meter readings.
7. Rewind the camera to cock the shutter and advance the film for the next frame. All settings remain until you change them manually.

⚠ The metering system can be started by depressing the AE-lock button as well. In that case the display starts by showing the difference as at 5' above.

ML - manual, locked position

The ML mode is almost the same as the M mode except that the selected shutter speed cannot be changed. It is indicated by an 'L' on the display.

WARNING FUNCTIONS

Whenever the camera settings could result in an exposure error the red warning triangle flashes whereas permanent warning functions are built into the system and cannot be changed or disabled.

Battery capacity warning

When the battery voltage drops below a certain point, the battery symbol is displayed for at least two seconds and the warning triangle flashes twice.

⚠ Battery recovery may cause the battery symbol to disappear after the two seconds.

26

4. Depress the exposure button to the pressure point. The camera works according to the selected mode. When the exposure button is depressed to the pressure point the display appearance is according to that mode and for the described flash indications.

5. Depress the exposure button fully to make the exposure and trigger the flash. The control circuits in the camera cut the flash when the exposure is correct. Release the exposure button. If the flash was powerful enough to produce a correct exposure but did not use up all the power the flash symbol stays on and the display returns to its normal appearance. On the other hand if so much power had been used that the remainder was insufficient for a correct exposure, the flash symbol turns off while the flash unit is recharging and lights up again when it is fully recharged.

WARNINGS:

The sign "Hi FLASH" appears on the display when the flash was too strong, e.g. if the flash-to-subject distance was too short, the camera aperture too large, the film too fast or any combination of these. The remedies are to move the flash away from the subject (use a lens with longer focal length), reduce the aperture or change to a slower film. The sign "Lo FLASH" appears when the flash was insufficient to give a correct exposure, e.g. if the flash-to-subject distance is too long, the aperture is too small, the film too slow. The remedies are to lessen flash-to-subject distance, increase the aperture or use faster film. It also appears at shutter speeds faster than 1/90 s when the flash triggering was disabled and the exposure was made. In both cases the suggested remedies could be combined in any desired way. Both warnings appear for two seconds after the flash exposure together with a flashing triangle and backlighting, appearing in both the internal display as

28

well as in the display backlighting window on the outside of the camera.

8. Rewind the camera to cock the shutter and advance the film to the next frame.

Non-dedicated flash units

With a non-dedicated flash unit you cannot take advantage of the sophisticated TTL/OTF flash metering and control system in the 202FA and the viewfinder information supplied by this system. You will have to rely on the control system of the flash itself or your own aperture calculations. Always refer to the flash instruction manual for flash settings and guide number. The non-dedicated flash unit should be connected to the PC-socket next to the SCA socket on the left hand side of the camera body by a conventional synchronization cord usually supplied with the flash unit. The metering system and the viewfinder display in the camera will work normally in all operating modes as if no flash was connected, i.e. the flash symbol in the viewfinder will not light up when the flash is ready.

⚠ The fastest shutter speed for full flash synchronization is 1/90s. At faster speeds the PC-terminal is disconnected and the flash is not triggered. Use the camera's M mode and the 1/90 s shutter speed to ensure that the flash will

30

Shutter speed warning

106-107

When the calculated shutter speed is slower than 90s or faster than 1/1000s the shutter speed indication and the red warning triangle start flashing.

Light meter range warning

100-109

When the light value falls below or above the range of the light meter the indication "Lo" or "Hi" resp. appears in the left hand part of the display. If no other light value is stored the warning triangle flashes.

Flash photography warnings

110-111

In dedicated flash photography the indication "Hi FLASH" or "Lo FLASH" is displayed together with the flashing warning triangle and display backlighting if the flash was too bright or if it was insufficient. This warning is on for 2 seconds after the exposure.

Flash Photography

The 202FA is an excellent camera to use in connection with flash photography. When a dedicated flash unit or a European SCA-standard unit is attached, the TTL/OTF features provide optimum reliability and dependability. Other flash units can be used but the superior benefits of integral flash control from the 202FA will be lost.

Dedicated flash units

112

The flash control function in the 202FA works behind the selected mode of operation, which basically remains unchanged. The film speed range for the flash function is

as well as in the display backlighting window on the outside of the camera.

6. Rewind the camera to cock the shutter and advance the film to the next frame.

Flash set at automatic mode

The flash unit should be set for its own built in automatic control (see the flash unit instructions).

Functions:

- Automatic exposure control through the built-in system in the flash unit.
- Exposure with pre-set aperture and shutter speed determined by the selected operating mode.
- Viewfinder indication when the flash unit is charged and ready to flash.
- Viewfinder warning at over- and under exposure and disabled flash triggering.

Suggested procedure:

126-135

1. Attach and connect the flash according to the Flash Manual. With the Hasselblad D-Flash 40, connect the TTL cable between the dedicated flash socket in the camera body and the TTL socket in the flash unit.
2. When the flash unit is charged and ready to flash, the green flash symbol lights up in the viewfinder.
3. Select and pre-set the lens aperture for the desired depth-of-field.
or
set the aperture according to the 'flash illumination range' chart corresponding with the desired distance.
4. Depress the exposure release or the pre-release button to the pressure point to start the camera. The camera operates in the selected mode and the display shows the corresponding indications.

fire. Since the metering system automatically calculates and sets the correct shutter speed in the A and D modes you must monitor the viewfinder display closely to check that the shutter speed is 1/90 s or slower before making the exposure. Change the pre-set aperture or use the adjustment buttons to change the shutter speed if necessary.

How to use a non-dedicated flash unit

146-148

Suggested procedure:

1. Connect the flash to the PC-socket on the camera body and switch it on.
2. Turn the flash unit on.
3. Set the desired aperture.
4. Use the camera as described in any desired operating mode, keeping a check on the shutter speed in the A and D modes. Pre-set the shutter speed 1/90 s in M mode.

202FA with F and CF Lenses

You can use the Hasselblad F, CF (at the F setting) range of lenses on your 202FA without fear of damaging camera or lens. Since these lenses do not have the electronics required by the metering system, there will be a few minor limitations in the camera functions.

ISO 25 - 1000. When a dedicated flash unit, such as the Hasselblad D-Flash 40, or another unit complying with the European SCA-standards is connected to the dedicated flash socket - directly or through a suitable adapter and switched on, the green flash symbol in the viewfinder automatically lights up when the flash is charged and operative. If a plus or minus flash metering adjustment has been entered, the right hand plus/minus sign also appears in the display.

Your 202FA controls the flash duration by TTL/OTF metering (TTL=Through The Lens; OTF = Off The Film), i.e. it meters the light reflected off the film and terminates the flash when the exposure is correct. There is of course also the possibility of connecting the flash unit to the PC socket, but then you no longer have the advantage of letting the camera system control the flash and the exposure. The camera continues to operate in the selected mode with the calculated or pre-set shutter speed. If an automatic mode is desired for the camera the D mode is recommended. Meter the selected subject area, lock the metered value and make the desired adjustments. Then adjust the aperture or use the adjustment keys until the shutter speed figure stops flashing to be sure that the shutter speed will be slower than 1/90 s. Note that even the displayed 1/90 s could be flashing!

⚠ If the shutter speed is faster than 1/90 s the shutter speed display flashes and no sync signal is generated to trigger the flash.

Using a dedicated flash unit

Described below are three different methods of using a dedicated flash unit according to mode, namely:

5. Depress the exposure release button fully to make the exposure and trigger the flash. The control circuits in the flash unit cut the flash when the exposure is correct. If the flash was powerful enough to produce a correct exposure and did not use up all the energy the flash symbol stays on. On the other hand if so much power had been used that the remainder was insufficient for a correct exposure, the flash symbol turns off while the flash unit is recharging and lights up again when it is fully recharged.

WARNINGS:

The sign "Hi FLASH" appears on the display when the flash was too strong, e.g. if the flash-to-subject distance is too short, the camera aperture too large, the film too fast or any combination of these. The remedies are to move the flash away from the subject (use a lens with longer focal length), reduce the aperture, change to a slower film. The sign "Lo FLASH" appears when the flash was insufficient to give a correct exposure, e.g. if the flash-to-subject distance is too long, the aperture is too small, the film too slow. The remedies are to lessen flash-to-subject distance, increase aperture or to use faster film. It also appears at shutter speeds faster than 1/90 s when the flash triggering was disabled. Both warnings appear together with a flashing backlight display for two seconds after the flash exposure.

6. Rewind the camera to cock the shutter and advance the film to the next frame.

Flash set at manual mode

The flash unit should be set for manual control (see the flash unit instructions).

Functions:

- Exposure with pre-set aperture and shutter speed

F lenses

149, 150

The F lenses are optically, mechanically and operationally identical with the corresponding FE lenses but are not equipped with their internal electronics and external identifications. The instructions for the FE lenses are generally applicable also to the F lenses.

⚠ With an F lens on the camera the aperture value does not appear in the viewfinder display when the exposure or pre-release button is depressed. Instead the display shows two dashes (-).

Using the 202FA with an F lens

151-153

Like all Hasselblad lenses, the F lenses are normally opened up to the largest aperture in viewing position but can be stopped down manually to the pre-set aperture. Since no information on the pre-set aperture is transferred to the metering system in the camera body the shutter speed calculated by the system relates to the actual lens aperture. To get a correctly calculated shutter speed you have to stop down the lens to the pre-set aperture before you make the exposure. With the extraordinary brightness of the Acute-Matte focusing screen there are usually no difficulties in focusing with a stopped down lens.

Suggested procedure:

1. Pre-set the film speed as previously described.
2. Pre-set the desired aperture value.
3. Set the mode selector dial to the desired mode of operation.
4. Stop down the lens by pushing the preview knob down until it locks.
5. Follow the instructions for the selected mode of operation.

- Flash set at TTL mode.
- Flash set at automatic mode
- Flash set at manual mode

For the operation of the flash unit see the flash unit instruction manual.

Flash set at TTL mode.

Functions:

- Fully automatic exposure control through TTL/OTF metering.
- Exposure with pre-set aperture and shutter speeds slower than 1/90 s.
- Pre-set flash exposure adjustment -3 to +1 EV through Pr mode indicated by the right hand minus / plus sign.
- Display warning when the pre-set or calculated shutter speed is faster than 1/90 s.
- Viewfinder indications when the flash unit is charged and ready to flash.
- Viewfinder warning at over- and underexposure or disabled flash triggering.

Suggested procedure:

113-125

1. Attach and connect the flash according to the flash manual.
2. Set the flash unit at TTL or corresponding mode and switch it on. Activate the camera. When the flash unit is charged and ready to flash the green flash symbol lights up in the viewfinder. If a flash power adjustment has been entered, the r.h. plus/minus sign also appears in the display.
3. In manual mode, pre-set the aperture and set the shutter speed not to exceed 1/90 s. In automatic mode follow the recommended procedure!

27

determined by the operating mode.

- Viewfinder indication when the flash unit is charged and ready to flash.
- Viewfinder warning at over- and under exposure and disabled flash triggering.

Suggested procedure:

136-145

1. Attach and connect the flash according to the flash manual. With the Hasselblad D-Flash 40 connect the TTL cable between the dedicated flash socket on the camera body and the TTL socket on the flash unit.
2. Set the flash unit to Manual or corresponding mode and switch it on. When the flash unit is charged and ready to flash, the green flash symbol lights up in the viewfinder.
3. Estimate the flash-to-subject distance or measure it by focusing the lens and reading the distance from the focusing scale.
4. Determine the aperture setting using the aperture calculator on the flash unit or the guide number (see the flash unit manual).
5. Depress the exposure release or the pre-release button to the pressure point to activate the camera that operates in the chosen mode. The display indicates the aperture setting, the shutter speed, mode and flash information.
6. Depress the exposure release button fully to release the exposure and trigger the flash. In Manual mode the flash normally uses all the accumulated power.
7. The flash symbol therefore is turned off and is displayed again when the unit has re-charged sufficiently.

WARNINGS:

The sign "Hi FLASH" appears on the display when the flash was too strong, e.g. if the flash-to-subject dis-

29

Flash photography with F lenses

The overall similarity between the FE- and F lenses makes the flash photography procedures almost identical. The only difference is that the aperture value does not appear on the viewfinder display.

Dedicated flash unit

The TTL/OTF flash control system does not differentiate between the FE and F lenses as it always operates when the lens is stopped down during the exposure.

How to use a dedicated flash unit

The procedures are identical to those described for the FE-lenses in all flash and camera modes of operation.

Non-dedicated flash units

The information and procedure described for the use of a non-dedicated flash unit together with an FE lens is in every way applicable to an F lens.

CF lenses

154

The setting rings and scales on the CF lenses are arranged differently from those on the F lenses. Counted from the camera body and forwards the rings are:

- Focusing ring with focusing distance scale in feet (orange) and meters (white).
- Common index line and depth-of-field scale.
- Aperture ring with aperture scale and EV index (orange).
- Shutter speed ring with shutter speed scale, EV scale (orange) and F lock button (green).

31

Depth-of-field preview knob

155

The depth-of-field preview knob location and operation is identical to the FE and F lenses.

F-setting

156

Depress the small green F-lock button to the left of the green F on the shutter speed ring. Keep it depressed while turning the ring to align the F with the index line. Release the button to lock the ring in the F position. The F setting locks the shutter wide open without interfering with the aperture function. With this setting the lens works exactly as an F lens.

⚠ CF lenses can only be used at the F-setting with the 202FA.

CF lens in F mode and flash photography

Dedicated and non-dedicated flash units
The procedures are identical to the corresponding procedures for the F-lens.

How to use a dedicated flash unit

Suggested procedure:

1. Attach the flash to the camera if desired.
2. Connect the TTL-cord according to flash instructions.
3. Connect the PC-connector to the PC socket on the camera body.
4. Set the flash unit to the desired mode of operation and switch it on. The green flash symbol in the viewfinder lights up when the flash is ready to fire.
5. Select shutter speed on the camera and pre-set aperture on the lens.
6. Press and release the exposure button to make an

exposure, observing the view finder display for warning indications.

7. Rewind the camera to cock the shutter and advance the film to the next frame.

Accessories

All accessories originally designed for the 202FA are marked with double blue lines. This marking is always located on that side which is to the left when the accessory is attached to the camera to make it easily identified.

Other accessories are so called "general accessories". These accessories do not have the double blue lines but can still be used on the 202FA without restrictions.

A third group of accessories can be used but will cause certain limitations to the TCC functions.

Finally there is a fourth group of accessories that are not compatible with the 202FA.

Accessory mounts

The quick coupling plate on the bottom of the camera body fits the handy and reliable Hasselblad Tripod quick-coupling S and the Snap-lock flash grip. On the front of the lenses are external and internal bayonet mounts for filters, close-up lenses and lens shades. The viewfinder mount on top of the camera body accepts various focusing screens and viewfinders. Underneath the winding crank is a bayonet mount for the Hasselblad Winder.

Major FE accessories (TCC)

A selection of the most important FE accessories is described below. For a complete review of the Hasselblad system refer to the Hasselblad Product Catalogue.

Winder

157

The Winder F motorizes the 202FA for a maximum frame rate of 1.3 frames per second.

Viewfinders

158

Besides the focusing hood which is delivered with the camera body you have a choice of a magnifying hood and prism viewfinders with and without exposure meters.

E-type extension tubes for close-up and macro photography

159

The E-type extension tubes have all connections, both mechanical and electronic, between camera body and lens.

External battery cassette

160

The external battery cassette connector replaces the original battery cassette in the battery compartment. It provides additional power and the extension cord allows you to keep the batteries warm in your pocket when you are using the 202FA in cold conditions.

General Accessories

The range of general Hasselblad accessories that can be used on the 202FA without affecting the metering functions includes different focusing screens, lens shades and filter adapters. There is also the Hasselblad D-Flash 40 dedicated flash unit. Other dedicated flash units can be connected through flash adapters, such as the Hasselblad SCA 390.

Other accessories

These accessories can be used but will result in certain limitations to the metering system. The F and CF lenses belong to this group, as do the bellows and the PC-Mutar. Finally there is a group of accessories which cannot be used on your 202FA, such as the other viewfinders, the grips and the accessories designed to be attached to the accessory rail on the other Hasselblad reflex models.

The Hasselblad System Chart, fig 162, illustrates the different groups of accessories in the Hasselblad System relevant to the 202FA. The coloured section marked A includes the primary accessories. The coloured section B contains the accessories that can be used without affecting the metering function. The coloured section C contains the accessories that would affect the metering function. Refer to the Hasselblad Product Catalogue for complete information about the entire Hasselblad System.

32

Troubleshooting

Your Hasselblad 202FA is built for long and trouble-free service. Should you encounter any operational difficulties the troubleshooting chart below may help you to resolve them. If the problem persists, consult an Authorised Hasselblad Service Centre.

Problem	Possible cause	Remedy
The camera cannot be activated in anyway.	<ul style="list-style-type: none"> • The battery has been removed or is completely exhausted. • The battery has been fitted incorrectly. 	<ul style="list-style-type: none"> • Install or replace the battery.
The camera cannot be activated by depressing the AE lock.	<ul style="list-style-type: none"> • The camera has not been rewound after the last exposure. • The AE lock has been depressed for more than 16 seconds. 	<ul style="list-style-type: none"> • Insert the battery according to the markings on the battery cassette. • Wind the camera with one full turn of the winding crank. • Activate the camera by depressing the exposure release button.
The exposure release button cannot be depressed.	<ul style="list-style-type: none"> • The camera has not been rewound after the last exposure. • The magazine slide is in the magazine. • The film is finished (frame counter at end). 	<ul style="list-style-type: none"> • Rewind the camera with one full turn of the winding crank. • Remove the magazine slide completely. • Insert a new film or change to a fully loaded magazine (or w/o film, remove and re-insert film holder).
The viewfinder image is dark but the display is bright.	<ul style="list-style-type: none"> • The lens front cover is on. • The camera is pre-released. 	<ul style="list-style-type: none"> • Remove the lens front cover. • Complete the camera release or depress the double exposure button and wind the camera with one full turn of the winding crank.

34

Problem	Possible cause	Remedy
The magazine symbol appears when an E magazine is attached.	<ul style="list-style-type: none"> • Defective contact between magazine and camera body. 	<ul style="list-style-type: none"> • Detach the magazine. Clean all four contact surfaces on the magazine and on the camera body with a lint free cloth or suede. Do not touch the contact surfaces with your fingers!
The display indicates "Err 1", "Err 2" or "Err 12 4", possibly together with A or M.	<ul style="list-style-type: none"> • Electronic system error. 	<ul style="list-style-type: none"> • Take the camera to an authorized "Hasselblad Service Center". Describe what appears in the display to the service technician.

⚠ If there is a contact failure between the lens and the camera body you can still use your equipment according to the instruction for the F lens. Contact failure between the magazine and the camera body could be overrun by selecting P mode and entering the film speed manually.

36

Problem	Possible cause	Remedy
The lens cannot be attached.	<ul style="list-style-type: none"> • The lens is released. • The camera body is pre-released or released. 	<ul style="list-style-type: none"> • Cock the lens. • Release and/or rewind the camera with one full turn of the winding crank.
The lens cannot be detached.	<ul style="list-style-type: none"> • The camera is pre-released or released. 	<ul style="list-style-type: none"> • Release and/or rewind the camera with one full turn of the winding crank.
The magazine cannot be detached.	<ul style="list-style-type: none"> • The magazine slide is not completely inserted. 	<ul style="list-style-type: none"> • Push the magazine slide in until it positively stops.
The flash symbol does not light up when a dedicated flash unit is connected.	<ul style="list-style-type: none"> • The flash unit is not switched on or is not fully charged and ready to be fired. • The connection between flash unit and camera is defective. 	<ul style="list-style-type: none"> • Switch on the flash unit and/or wait until it is fully charged. • Check the connections according to the flash unit's manual. • Replace the TTL sync cord.
The display signs appear reversed.	<ul style="list-style-type: none"> • The viewfinder is not properly installed. 	<ul style="list-style-type: none"> • Push the viewfinder firmly forwards until it stops.
Aperture indication is "∞-"	<ul style="list-style-type: none"> • Defective contact between lens and camera body. 	<ul style="list-style-type: none"> • Detach the lens. Clean all four contact surfaces on the lens and on the camera body with a lint free cloth or suede. Do not touch the contact surfaces with your fingers!

33

Technical Specifications and Equipment - 202FA

Camera body	One-piece, cast aluminium alloy shell with tripod socket and tripod plate for rapid mounting.
Film advance	Manual with crank. Motor driven with winder accessory; maximum speed 1.3 frames per second. Simultaneous shutter cocking and film advance. Instant return mirror in both modes.
Film format	6x6 cm and 6x4.5 cm with different magazines. Film choice 120 and 220 roll-film, 70 mm perforated long rolls and Polaroid film with different magazines.
Shutter	Focal plane shutter, with electronically controlled speeds from 34 minutes (90 sec. in Auto modes) to 1/1000 s and B. Manual shutter speed setting in half stop increments.
Exposure metering	TTL metering at full aperture with FE lenses. Selective metering measuring approx. 20% of the image area. Metering range EV 0.5 - EV 21.5 at ISO100 and f/2.8. Exposure adjustment +5 stops in 1/3-stop increments.
Exposure modes	Aperture priority automatic exposure using A-mode or D-mode. Manual exposure using M-mode. Electronic shutter speed lock.
Film sensitivity	Automatically transferred via digital data bus from E and TCC-magazines or manually programmed value. Range ISO12- 6400.
Flash sync	Up to 1/90 s with focal plane shutter.
Flash control	TTL centre-weighted dedicated system with OTF metering. Useable with a wide variety of flash units using appropriate adapters (e.g. SCA390 or SCAS90) and focal plane or lens shutter. Film speed range ISO25 to 1000. Flash output can be programmed with a separate adjustment for use as fill-in flash.

35

37

Viewfinder display	LCD and LED indications with low light illumination above the image area.
Viewfinder and focusing screens	Bright Acute-Matte D* interchangeable for other types. Full viewfinder image with all lenses and accessories. Standard foldable focusing hood with 4.5x magnifier interchangeable with 90° or 45° prism finders (with or without exposure meter) with high eyepoint eyepieces or magnifying hood with built-in diopter correction eyepiece.
Lenses	Carl Zeiss large aperture FE-lenses with digital data bus connections. 50, 80, 110, 150, 250 and 350 mm. Carl Zeiss Tele-Superachromat CFE 5.6/350. Hasselblad Zoom lens f4.8/60-120. All CF and CFE lenses (at F-setting only) from 30 to 500 mm. Converter 1.4X, Teleconverter 2X, PC-Mutar 1.4X Shift Converter.
Individual programming	In Pr-mode the user can program camera functions: manual ISO-value, self-timer delay and flash exposure adjustment.
Camera operation	Smooth front release. Built-in self-timer programmable from 2 to 60 s delay with operating signal on camera. Double exposure without removing the magazine. Instant return mirror.
Battery	GV PX28L Lithium type or equivalent. Automatic battery control in viewfinder.
System compatibility	All lenses and film magazines made since 1957. TCC Viewfinders, winders and most other accessories.
External dimensions	With Zeiss Planar FE 2.8/80 mm lens, focusing hood, and magazine E12: length 185 mm (7.3"), width 117 mm (4.6"), height 110 mm (4.3"). Body only: length 88 mm (3.5"), width 117 mm (4.6"), height 110 mm (4.3").
Weight	With focusing hood, Planar FE 2.8/80 mm lens, magazine E12 and battery: 1630 g (3lb 9oz). Body only: 750 g (1lb 10oz).

38

Equipment Care, Service and Guarantee

EQUIPMENT CARE

The Hasselblad 202FA is designed to withstand the rigours of professional use in most environments. To avoid the possibility of damage however, it should be protected from the following:

Extremes of temperature. High temperatures can have an adverse effect on both film and equipment. Try to avoid frequent and severe temperature changes. Be particularly careful in humid environments. Corrosion of electrical contacts may occur in these situations if sufficient care is not taken. Allow the equipment to acclimatise before disassembly. Try to ensure the storage conditions in such environments are as dry as possible.

Dust and grit. You should take care to prevent dust and grit from getting into your equipment. In coastal areas take measures to protect your equipment from sand and salt water spray. Dust on the lens glass and focusing screen can be removed with a blower brush or very soft lens brush if necessary. Smears on the lens glass should be treated with great caution. In some cases they may be removed with a high quality lens cleaning solution on a tissue but be careful not to scratch the lens or touch any of the glass surfaces with your fingers. If in any doubt, do not attempt to clean lens glass surfaces yourself but allow a "Hasselblad Authorized Service Center" to treat them.

Impact. Your equipment can be damaged by severe physical shocks so practical protective precautions should be taken. When not in use, try to make a habit

of storing your camera equipment in some form of protective case or bag to avoid accidental damage.

Loss. Hasselblad equipment is much sought after and you should take obvious steps to prevent theft. Never leave it visible in an unattended car, for example. Separate and specific camera insurance cover should be considered by professional users.

SERVICE

You should return your equipment to a service centre for occasional checking and preventive maintenance to ensure optimal reliability. If your camera is used constantly and intensively, periodic check-ups every six months are recommended at one of the "Hasselblad Authorized Service Centers". They have the expert staff and specialised equipment necessary to ensure that your equipment remains in perfect working order.

GUARANTEE

Provided that you bought your equipment from an authorised Hasselblad outlet, it is covered by an international guarantee for one year. The guarantee document and a registration card are supplied with the camera. Keep the guarantee document carefully, but fill in the registration card and return it to your Hasselblad distributor.

39

Catalogue no:	
chrome:	10542
black:	10546
standard kit, chrome:	11099
standard kit, black:	11101

Hasselblad reserve the right to make changes in the published specifications without prior notice.

All rights reserved. No part of this material may be reproduced, stored in a retrieval system, or transmitted, in any form or by any means, electronic, mechanical, photocopy, recording, or otherwise, without the prior written permission of the company.

Copyright © 1998, Victor Hasselblad AB



HASSELBLAD

Victor Hasselblad AB
Box 220, S-401 23 Göteborg, Sweden
<http://www.hasselblad.se>
<http://www.hasselblad.com>